

Quality is more than a word

ESPEC

Walk-In Type Temperature (& Humidity) Chamber E Series



New N-instrumentation produces a smart chamber Leading eco model better than ever

The E Series walk-in type chamber is already renowned for its epoch-making power savings. Power savings achieved thanks to a wide-range refrigeration control system, an active map system, and other original control devices. Energy reduction accounts in some cases for half of the previous model consumption, due to the development of a cross output control system (patented) lowering electrical requirements of temperature & humidity operation and many other features.

Energy consumption is, more than ever, an important issue to address in our line of business. Now, the E Series capabilities are even further optimized thanks to the N-instrumentation, allying highly-accurate controllers with user-friendly interactive input system to support easy operation and network solutions.

Dramatic reduction in power consumption, smother airflow, etc. improved the temperature distribution and allowable heat load, and seal material has been designed to minimize unpleasant odors.

The E Series chamber has been brought to a new level of excellence.





SERIES

	Model	Temperature	Humidity	Inside capacity (Floor Area)	Refrigerator System
Temperature & Humidity Chambers	Temperature & Humidity Chamber EBE	-40 to +80°C	10 to 95%rh	Type 1: 4.2m ³ (2.0m ²) Type 2: 8.1m ³ (3.9m ²) Type 3: 12.5m ³ (5.9m ²) Type 4: 16.8m ³ (8.0m ²) Type 6: 25.8m ³ (12.3m ²) Type 8: 34.8m ³ (16.6m ²) Type 10: 43.8m ³ (20.8m ²) Type 12: 52.7m ³ (25.1m ²)	Air-cooled Water-cooled
	Temperature & Humidity Chamber EBL	-30 to +80°C	10 to 95%rh		
	Temperature & Humidity Chamber EBR	-10 to +80°C	20 to 95%rh		
Temperature Chambers	Temperature Chamber EBF	-40 to +80°C			
	Temperature Chamber EBU	-30 to +80°C			
	Temperature Chamber EBUU	-10 to +80°C			

System configuration

Test chamber variations

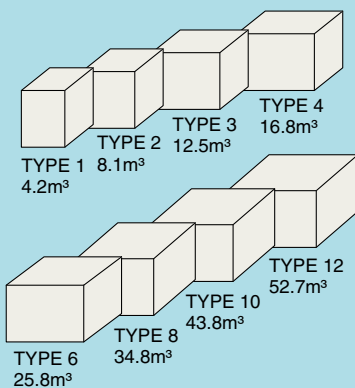

Mechanical compartment variations

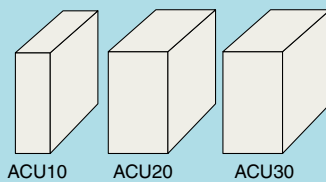

Refrigerator

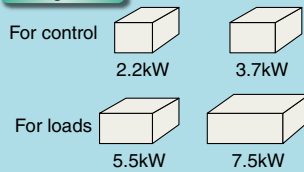

Program control operation

Options

Custom configuration

Characteristics

Networking communications and USB data transfer for optimum test operations

● Networking with new N-instrumentation Supports chamber control from a variety of terminals

The tabbed user interface of the chamber instrumentation is designed to make operations for accessing to specific screens easier than ever.

An Ethernet (LAN) port is equipped as standard, so it is possible to connect to and monitor the chamber operation conditions from a device such as a PC or tablet PC. As an option, a Web browser can be used to communicate with chambers to perform tasks such as modifying test conditions and even starting and stopping operation. Besides more, the remote communication area can be expanded by connection to an intranet (a LAN inside your company).



● Security measures

Password authentication is required when accessing the USB flash drive. LAN port and/or USB port function can be terminated as required.

Interface

- Remote monitoring
- Operation* (Test pattern change, run start/stop)
- Program pattern edit and copy*
- Data management
- Email alert

*Option

● Remote monitoring

A Web browser running on a computer connected to a chamber over an ethernet connection can be used to monitor chamber running conditions. Simply connect the chamber to a computer via LAN and set the IP address. No software or drivers are required.

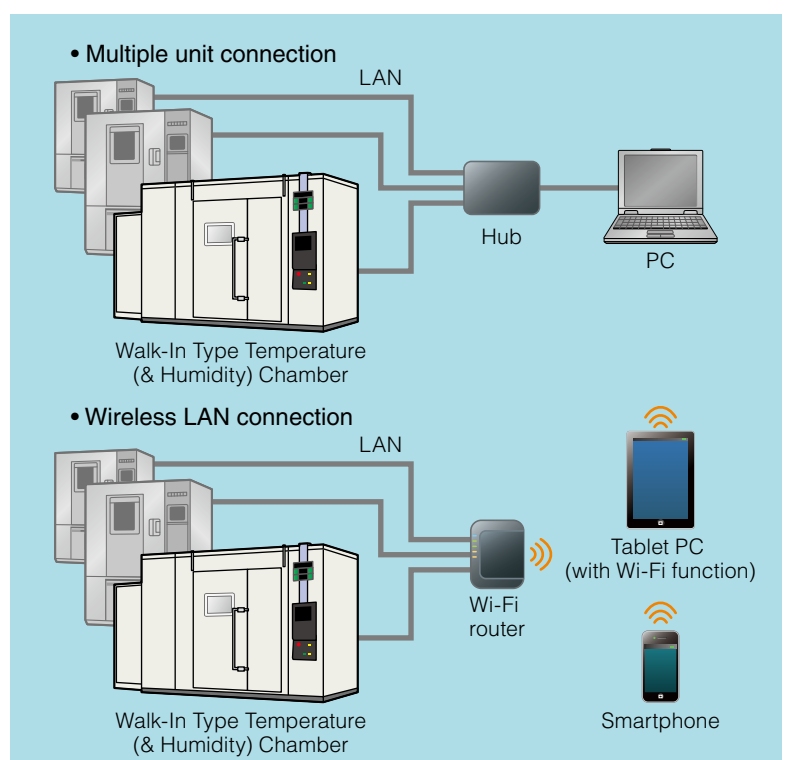
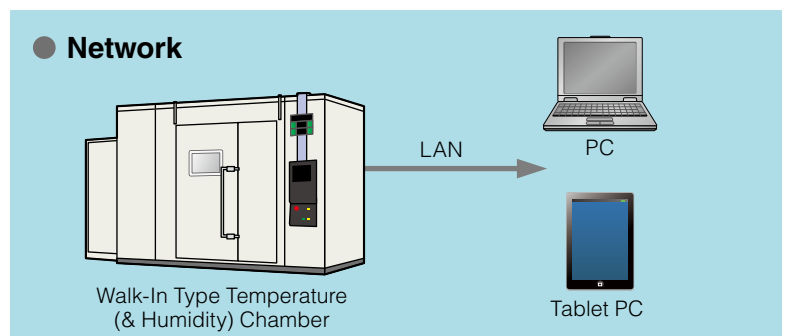

Characteristics

● Instrumentation panel

<LAN settings>



<External memory (USB) settings>

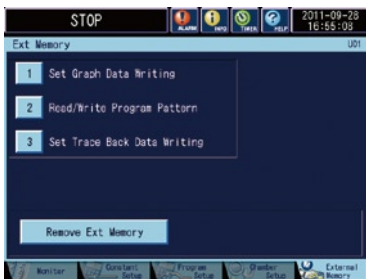

● PC screen

<Chamber monitor>

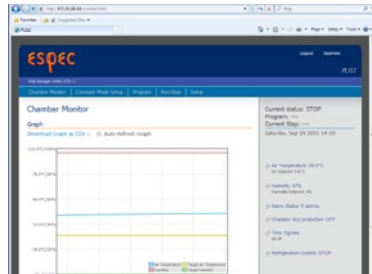

<Edit program (USB)>

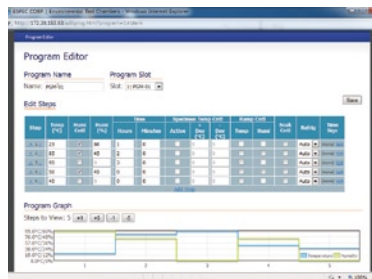

● Program pattern edit and copy

A program pattern created on a computer can be written to a chamber, and program patterns stored on a chamber can be copied to a computer via the USB interface.

● Downloading test programs

ESPEC's web-based Tech site "Test Navi" introduces various test standards related to environmental testing.

Test standards can be performed by downloading a test program to the computer connected to the chamber. A program pattern editing function enables modification of test profiles. In addition, accurate testing can be performed by using USB memory to copy data between chambers and transferring it directly to N-instrumentation.

* User registration is required to use the Test Navi website for engineers.
<http://www.test-navi.com/eng/index.html>

● Test Navi (<http://www.test-navi.com/eng/index.html>)



The web-based Tech site provides practical knowledge on environmental testing that ESPEC has acquired through years of experience, as well covering everything from the fundamentals to the latest information on environmental and reliability testing.

● Collecting chamber data

Network function or USB memory can be used to retrieve chamber operation log data.

Data can be opened as a list or graph thanks to a dedicated viewer or spreadsheet, and can be used to check historical data.

● Email alert

When an alarm is triggered, an email is sent to the registered PC or mobile address.

* Connection to a mail server is required to use e-mail alert.

● Email alert

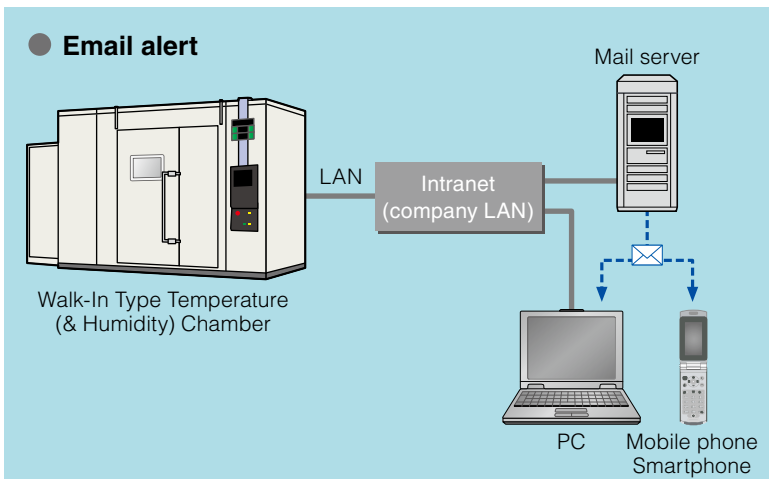

■ Copying and editing data on a computer with USB memory requires installation of the Pattern Manager Lite application software that comes with the chamber.

Characteristics

● Backtrace function

When the chamber stops because of trouble, the operation state just before the chamber stops is automatically recorded and saved. Saved data can be transferred by USB memory.

Attach this data file to an email to ESPEC, and we will perform troubleshooting.

● Online diagnostics services

Diagnostics service is available using the backtrace data from the time of trouble.

Send the backtrace data to ESPEC via email; we will analyze the cause of the trouble and report the diagnosis back to you.

This service ensures accurately-performed diagnosis so that, in the case that repair work is required, appropriate troubleshooting will be prescribed ensuring reduced testing downtime.

* Application page

<http://www.espec.co.jp/english/support/onlinediagnosticservice.html>



Backtrace setting

● Online diagnostics services

(<http://www.espec.co.jp/english/support/onlinediagnosticservice.html>)

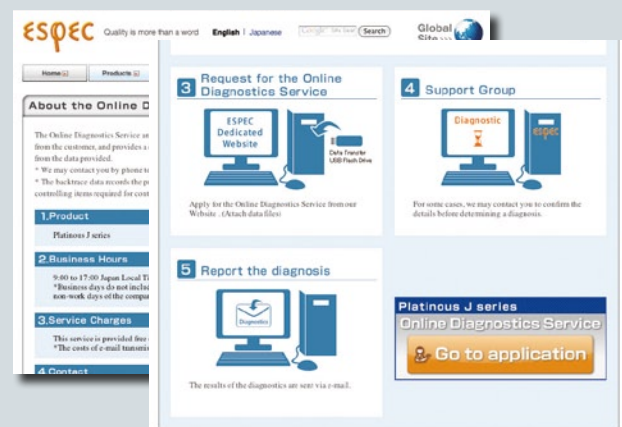

Characteristics

High-speed processing N-instrumentation and 10.4 inch color touch panel feature improved operability and legibility

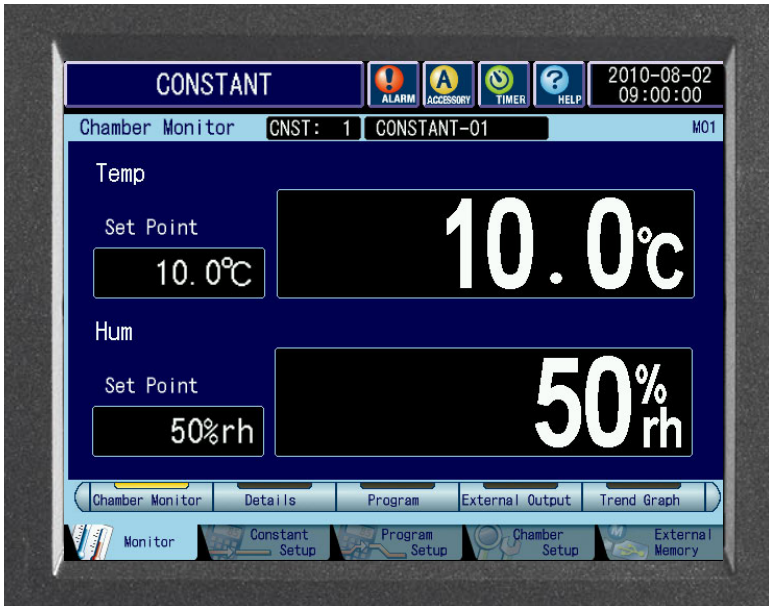

Control area (lower section option)



USB port

● Tabbed user interface

Controller's new layout includes tabs at the bottom of the screen to easily activate any section.

Calculating and processing performances have been improved, and the screen layout optimized.

● A variety of program settings

The program memory has a capacity for 40 patterns (1 pattern 99 steps). The time for each step is set in 1-minute increments up to a total of 9999 hours and 59 minutes. Steps can be inserted, copied, and deleted. Created patterns can be confirmed on the screen and operation can be started from intermediate steps.

● Sampling function

The temperature and humidity measurement targets, and measurement intervals can be set.

The trend graph with set conditions and data are saved in the controller memory. These data can then be transferred on a USB memory.

● Alarm function

If trouble occurs, the details, date, and time of occurrence are displayed on the alarm screen. The next screen shows the cause and recovery procedures.

● Calendar timer function

You can automatically start and stop the chamber at the desired time. The month, day, day of the week, and time can be set with the timer.

● Multi-lingual display

A simple operation changes display text to Japanese, Chinese (simplified, traditional), or Korean. Select the language that suits your needs.

Characteristics

N-Instrumentation

Operating mode	Constant operation, program operation, stop
Temperature & humidity control function	<p>Control system: PID control (sample temperature control support), energy-saving refrigeration capacity automatic control</p> <p>Temperature input: Test chamber temperature (Thermocouple type T)</p> <p>Humidity input: Test chamber wet-and-dry-bulb temperature input system (Thermocouple type T)</p> <p>Input functions: 100 ms high-speed sampling, wire break detection</p> <p>Adjustment function: Temperature offset setting</p>
Setting resolution	<ul style="list-style-type: none"> Constant setup <ul style="list-style-type: none"> Setting range: 3 patterns Setting range and resolution: <ul style="list-style-type: none"> Temperature: (lowest attainable temp. -5°C) to $+105.0^{\circ}\text{C}$, 0.1°C unit Humidity: 0% rh to 100% rh, 1% rh unit Program setup <ul style="list-style-type: none"> Setting range: 40 patterns (99 steps per program) Setting range and resolution: <ul style="list-style-type: none"> Temperature: (lowest attainable temp. -5°C) to $+105.0^{\circ}\text{C}$, 0.1°C unit Humidity: 0% rh to 100% rh, 1% rh unit Time: 0 hours 1 minute to 9999 hours 59 minutes, 1 minute unit
Language	English, Japanese, Chinese, Korean (switch without restarting)
Auxiliary functions	<ul style="list-style-type: none"> Refrigeration Power Mode (Normal/Eco) Input burnout detection High/Low Limit (Temp./Humid.) Setup Self-diagnostic Alarm Power Fail Recovery Setup (Operation Process) Set Timer (Start Timer, End Timer, Quick Timer) Refrigeration capacity automatic control Backup Mode Trend graph display Help (Set and Monitor, Alarm Report) Cross-output control Information Set Defrost Set Sampling User Check List Display
External memory functions	<ul style="list-style-type: none"> Interface <ul style="list-style-type: none"> USB 2.0 standard compliant (connector A-type) Supported functions <ul style="list-style-type: none"> Write log, read/write program (application software: Pattern Manager Lite), write backtrace
Web function	<ul style="list-style-type: none"> Interface <ul style="list-style-type: none"> Ethernet port (100base-TX) Server functions <ul style="list-style-type: none"> Remote monitor, remote setup (constant, program), remote operation, email alert Browser <ul style="list-style-type: none"> Windows Internet Explorer 7 or 8

● Constant operation registration

Register 3 patterns of constant operation in advance



● Programming

Register the program conditions per step



● Operation mode

Select registered operation pattern

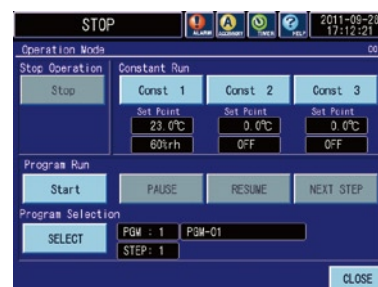

● Information

Show required items, such as inspections, etc.

Show a guide when selected



Characteristics

Allowable heat generation load comparison

Model	Temperature	E Series	Previous series
EBL-4	10°C	3.8kW	2.1kW
	20°C	6.6kW	3.2kW
	30°C	7.5kW	3.8kW
	40°C	7.5kW	4.3kW



Eco-mode selection screen

- **An automatic control system to quickly respond to load changes (Patented)**

Simply by setting the temperature and humidity conditions, the automatic control system works at maximum capacity up to the setting, and then after reaching it, can maintain it at minimum capacity (Japanese patent No. 2933269). It can quickly respond to door operations and changes in heat-generation loads during testing to create a constantly stable testing environment.

- **Improving temperature & humidity distribution performance/allowable heat load performance**

By improving the fan system so air flows more smoothly, and by increasing heat exchanger efficiency, the temperature and humidity distribution has an even higher degree of precision and the allowable heat load is improved.

(Heat exchanger: Patent pending)

- **Two modes for even more energy savings**

Selecting Eco-Mode reduces power consumption. Select the mode that suits current test conditions.

- **Achieves power and space savings with air conditioners optimized to performance requirements**

The system can be upgraded to an optimal chamber by matching the fan motor, heater, humidifier, and refrigerator that make up the air conditioner to the test area capacity and specimen heat load. We will customize the chamber to your needs.

Characteristics

Saving energy –major reduction in power consumption and power equipment capacity

● Featuring a new high precision cooling system with greatly reduced power consumption (Patent pending)

We have developed a wide-range cooling control system composed of a DC inverter that can widely and continuously vary refrigeration capacity an electronic expansion valve, as well as unique control methods such as the active map system to control the operation of multiple refrigerators at minimum power consumption. This cooling system controls output and refrigeration capacity with high precision and achieves both high performance and broad power savings. With automatic control, the system also demonstrates an even larger refrigeration capacity and quickly responds during rapid and large heat-generation loads and during sharp drops in temperature and humidity.

● Cross-output control reduces power equipment capacity (Japanese patent number 2928162) EBE, EBL, EBR

This is a large chamber with a wide test area, so a relatively high power capacity is required. When operations start, because the heater and the humidifier operate at the same time, the maximum current flows. The cross-output control limits the maximum currents of the heater and the humidifier. It controls the currents by giving priority to the heater and adjusting the humidifier. It may take some time to reach the set temperature and humidity, but it allows reducing the maximum current and thereby reducing the power equipment capacity. In addition, this feature can also be used to prevent dew condensation through delayed operation.

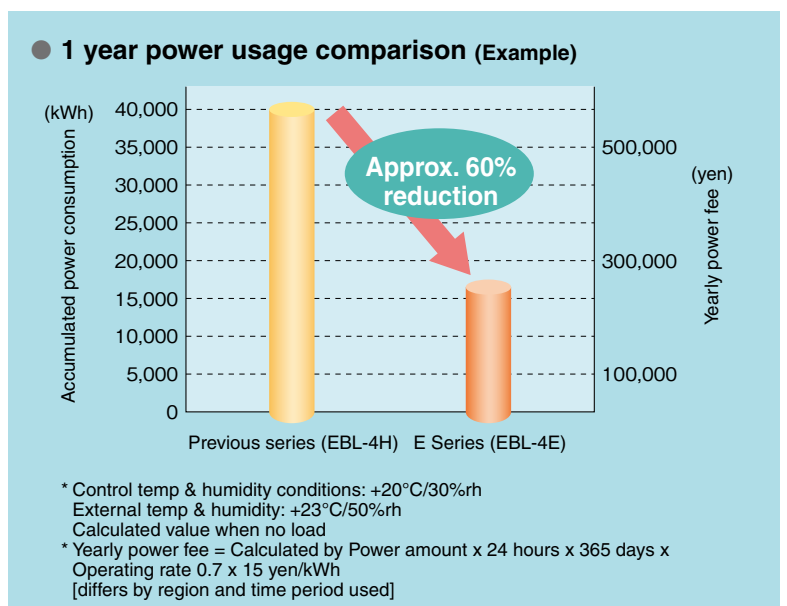
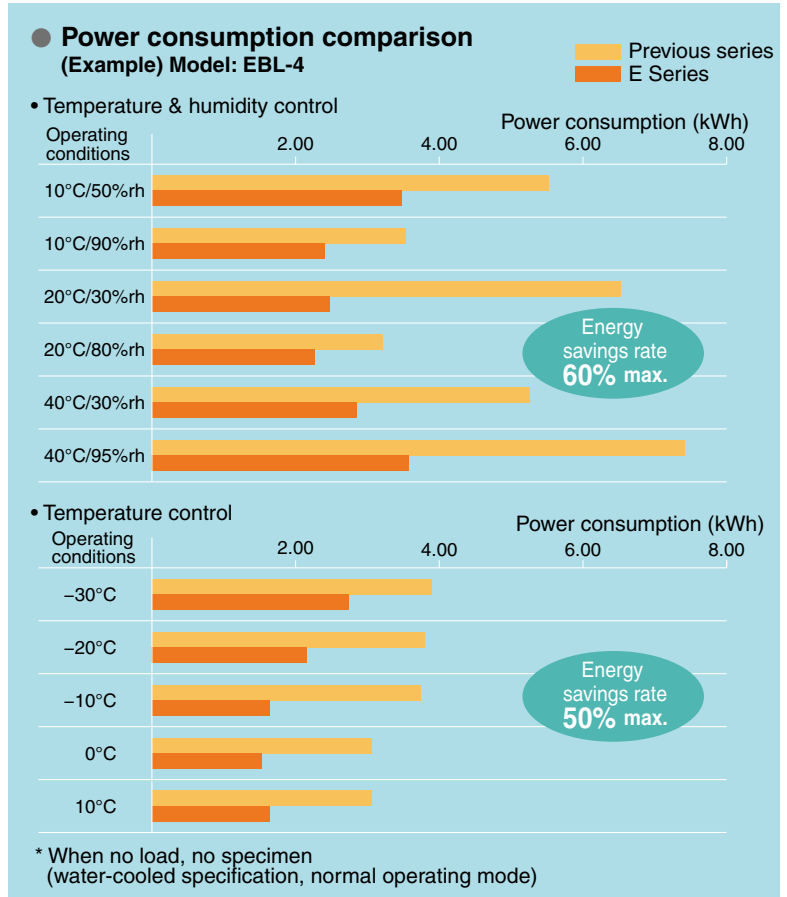

Characteristics



Viewing window
(W180 mm x H289 mm)



Option: Large viewing window
(W440 mm x H295 mm)



Automatic backup function

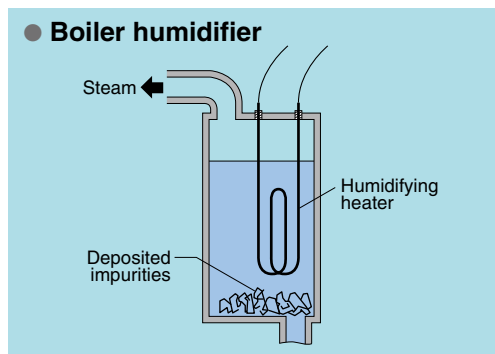

● Boiler humidifier

● The viewing window automatically prevents fogging

A heater in the viewing window door section automatically turns on according to the temperature setting and glass incorporating a heat generator is used to prevent fogging. A large viewing window option is also provided.

● Continue operation with the automatic backup function when trouble occurs

If a problem occurs with a portion of the chamber, the remaining devices can be flexibly run to continue operation, making it unnecessary to stop the test. If the humidifier breaks, the system will also switch to temperature operation.

● Employs a boiler humidification system with good humidifying efficiency

Impurities adhere with difficulty in the externally installed boiler humidification system because of automatic cleaning operations by exchanging the humidifying water. The cleaning period is announced through the instrumentation screen and cleaning is also performed outside the chamber.

● We deliver custom-made chambers

We will meet your demands to change chamber performance according to the content of tests and other requirements.

Custom-made specifications

High temperature specification	Highest adjustable temperature may be raised to +120°C by changing the insulation method.
Cryogenic specification	Equipped with a cascade refrigeration system for lowest temperature measurements even below -40°C.
Low-humidity specifications	Low-temperature/low-humidity control range may be expanded by using dry dehumidifier (ex. +5°C/5%rh)
Custom shape and size	Chamber with a capacity greater than Type 12 (standard specification) may be ordered. Adjustable height.
Shield installation	Shielding to eliminate electromagnetic noise that can be generated outside or inside the chamber (radio wave insulation).
Chamber without floor panel	The floor of the structure may become the floor of the chamber to allow heavy objects.
Outdoor air cooling specification	Refrigerator may be installed outside the building.
Low VOC specification	VOC concentration measurement
Noise-reduction specification	A sound-absorbing unit may be installed to reduce noise.
Increased safety specification	Pressure relief vent, fire extinguishing equipment, gas detectors, etc.

Characteristics

New features –Enhanced testing accuracy

● All-weather LED lights (Patent pending)

These LED lights now illuminates in the entire temperature and humidity control range. Allaying energy savings, long life, and excellent responsiveness when turned on, LED lights bring brightness (approx. 2.5x), and power consumption is reduced of approx. 1/5th compared to conventional incandescent lights illuminating the chamber.



Interior LED light

● Reduced odors/siloxanes

A new seal material used in the panel connections has been developed and generates no low-molecular siloxanes. This not only prevents any effect on the specimen from contact faults by siloxanes in the chamber, but also greatly reduces irritating odors from the seal material.

● Noise level in test area reduced of 10 dB (Traditional machine comparison: Mechanical compartment ACU10)

The air conditioning compartment's smooth air flow not only increases temperature and humidity distribution performance, it also decreases the occurrence of noise emissions in the test area. In addition to this smooth air flow, soundproofing materials have been added to the air conditioning compartment outlet to further reduce noise emissions.



Chamber interior

● Cycle time defrost system

The standard equipped defrost system can automatically remove frost from the evaporator when operating in the frosting range by simply setting the time via the cycle timer on the instrumentation.

● Frost-free expansion (option) (Patent pending)

Through the development of a low-temperature regenerative dehumidification system, the entire temperature & humidity control range is now frost-free and continuous operation time has been increased. The low humidity side control range has also been expanded. Power consumption has yet been reduced thanks to this system.

● Temperature & humidity control range with frost-free expansion (option)

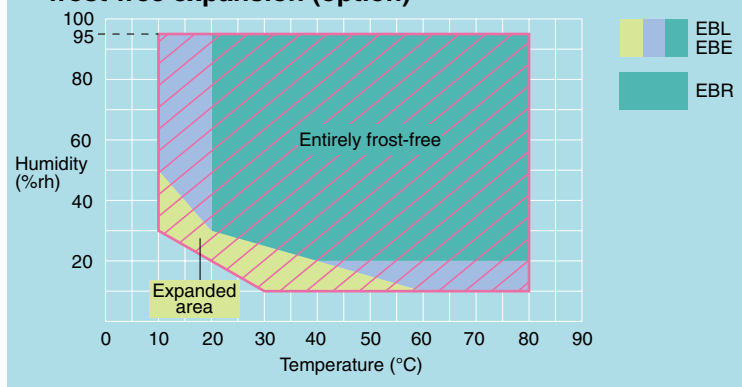

SPECIFICATIONS

Model	Walk-in Type Temperature & Humidity Chamber			Walk-in Type Temperature Chamber			
	EBE	EBL	EBR	EBF	EBU	EBUU	
System	Balanced Temperature and Humidity Control system (BTHC system) Vapor pressure divide control system (patent No. 2928151)			Balanced Temperature Control system (BTC system)			
Performance*1	Temp. range	-40 to +80°C (-40 to +176°F)	-30 to +80°C (-22 to +176°F)	-10 to +80°C (14 to +176°F)	-40 to +80°C (-40 to +176°F)	-30 to +80°C (-22 to +176°F)	-10 to +80°C (14 to +176°F)
	Humid. range	10 to 95%rh (at +10 to +80°C) (at +50 to +176°F)		20 to 95%rh (at +20 to +80°C) (at +68 to +176°F)	-		
	Temp. / Humid. fluctuation ²	±0.5°C (32.9°F)/±4%rh			±0.5°C (32.9°F)		
	Temp. / Humid. gradient ²	2.5°C (36.5°F)/8%rh			2.5°C (36.5°F)		
	Spatial temp. / humid. deviation ³	2.5°C (36.5°F)/8%rh			2.5°C (36.5°F)		
	Temperature extreme achievement time (Pull down) ^{3,4}	+20 to -40°C (+68 to -40°F) within 180 min	+20 to -30°C (+68 to -22°F) within 120 min	+20 to -10°C (+68 to 14°F) within 100 min	+20 to -40°C (+68 to -40°F) within 180 min	+20 to -30°C (+68 to -22°F) within 120 min	+20 to -10°C (+68 to 14°F) within 100 min
	Temperature extreme achievement time (Heat up) ²	+20 to +80°C (+68 to 176°F) within 60 min					
	Temperature rate of change (Pull down)	0.4°C (32.72°F)/min or higher					
	Temperature rate of change (Heat up)	1°C (33.8°F)/min or higher					
	Main unit (Panel assembly)	Exterior material	Color coated sheet metal				
Interior material		18-8 Cr-Ni stainless steel plate (SUS 304)					
Floor load resistance		Equal load distribution: 6 kPa (600 kgf/m ²)					
Door		Single opening door W850 x H1800 mm					
Insulation		Hard urethane foam					
Refrigeration system	Single-stage refrigeration system Air-cooled condenser or water-cooled condenser						
Machinery compartment	Fan motor, Humidifier, Heater, Refrigerator, Evaporator, Temperature sensor, Humidity sensor			Fan motor, Heater, Refrigerator, Evaporator, Temperature sensor			
Fittings	Viewing window (W180 x H289 mm), Cable port (Inside diameter 50 mm), Chamber lamp (LED), Ventilation system						
Utility requirements	Power supply	200V AC 3ø 3W 50/60Hz (with ±5% of rated voltage)					
		AC 220 V AC 3ø 50/60 Hz					
		AC 380 V AC 3ø 50/60 Hz					

*1 Performance in measurements at the control point after 30 minutes stabilization with no load and no specimen at an ambient temperature from +5 to +32°C.

*2 The performance values are based on to IEC 60068-3-6:2001 and JTM K09:2009 (EBE, EBL, EBR), IEC 60068-3-5:2001 and JTM K07:2007 (EBF, EBU, EBUU).

*3 The performance values are based on to IEC 60068-3-5:2001 and JTM K07:2007. However, the temperature sensor position is set to the outlet position.

*4 The temperature extreme (falling) attainment time with air cooling is performance at an outer temperature +25°C.

TEST CHAMBER MODULE (INSIDE DIMENSIONS)

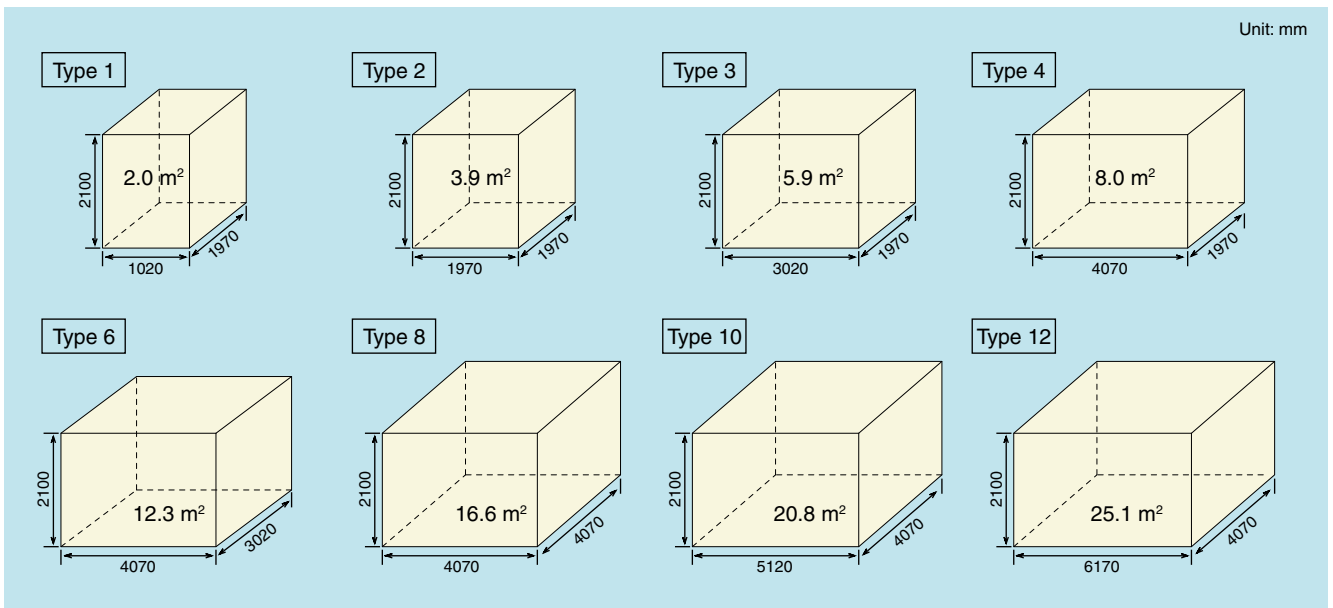

TEMPERATURE & HUMIDITY CONTROL RANGE

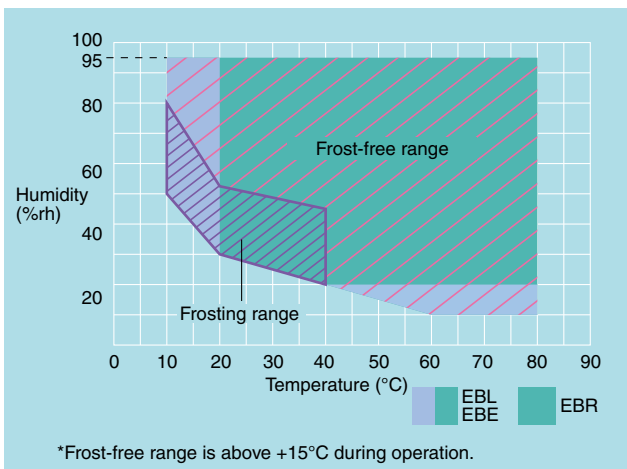

SAFETY DEVICES

- Control circuit overcurrent protection
- Glass tube fuse for control circuit short-circuit protection
- Air circulator short-circuit protection
- Electrical compartment door switch
- Specimen power supply control terminal
- System error (error/alarm)
- Room temperature compensation burnout detection circuit
- Dry bulb temperature burnout detection circuit
- Wet bulb temperature burnout detection circuit (T&H type)
- Absolute upper/lower temperature limit alarm (with built-in temperature/humidity controller)
- Reverse prevention relay
- Fan over current protection local overheating switch
- Overheat protector
- Heater overcurrent protection
- Heater short-circuit protection
- Refrigerator Temperature sensor burnout detection circuit
- Refrigerator Circuit temperature range over
- Refrigerator High-pressure (low-pressure) pressure switch
- Refrigerator Short-circuit protection
- Refrigerator Overcurrent protection
- Humidifier Overcurrent protection (T&H type)
- Humidifier Dry heat protector (T&H type)
- Dehumidifier Control circuit overload and short circuit protection fuse (T&H type)
- Humidifier Water level detection (T&H type)
- Temperature upper limit deviation alarm (with built-in temperature/humidity controller)
- Temperature upper limit deviation alarm (with built-in temperature/humidity controller) (T&H type)
- Water suspension relay (excluding cooling water)

OPTIONS

Status indicator light

Indicates three chamber states: OPERATION, PERSONNEL INSIDE, and ALARM.



Operation indicator

Indicates "OPERATION" during operation.



Personnel indicator

Indicates "PERSONNEL INSIDE" when workers have entered the temperature (humidity) chamber.

Alarm indicator

Indicates "ALARM" in red when a chamber fault occurs.

Revolving pilot lamp

In case of malfunction, the lamp connected to the safety circuit is activated, thus attracting the operator's attention even from a distance.



Operator safety mushroom

A mushroom-head button installed to protect workers who enter the temperature (humidity) chamber. When pressed, chamber operation stops and the safety buzzer issues an alarm.



Emergency stop pushbutton

Stops the chamber immediately.



Grounding terminal

A grounding terminal for test equipment used inside the temperature (humidity) chamber.



Electrical grounding in chamber

Each of the insulation panels are grounded and connected to the ground line in the power distribution board.

In-chamber work timer

The alarm lamp and buzzer is activated to inform the operators when the preset working time limit is over.

Intercom

Allows contact of personnel inside and outside the chamber.



Interior

Exterior

Cold-weather suit

We provide a set of protective clothing including headwear, a pair of gloves, a pair of boots and a two-piece suit. (For use in chamber under -40°C)

Leakage detector

Detects leakage with the leakage sensor.

Independent temperature overcooling alarm

In case of malfunction due to overcooling, operation is terminated and an alarm message is displayed, preventing freezing and damage to specimens inside the chamber.

Gas alarm

Detects concentrations of various gases in the chamber and activates a safety alarm when necessary to protect the personnel during a continuous operation.

OPTIONS

Paperless recorder

Records the temperature of each section such as the temperature inside the chamber. The data can be transferred by USB.

Data saving cycle: 5 sec.

External recording media:

- CF memory card port
(Includes a 256MB CF card)
- USB memory port

Languages: Can be switched between English/Japanese

<Temperature type>

Temperature range: -50 to +100°C
-100 to +100°C
-50 to +150°C
-100 to +200°C

Number of inputs: Temperature 1
(5 more channels can be turned OFF)

<Temperature and humidity type>

Temperature range: -50 to +100°C
-100 to +100°C
-50 to +150°C
-100 to +150°C

Humidity range: 0 to 100%rh

Number of inputs: Temperature 1/
Humidity 1
(4 more channels can be turned OFF)



Temperature & humidity type

Recorder (digital)

No. 1 -50 to +100°C 100 mm
6-dot system

No. 2 -50 to 100°C/
0 to 100%rh 100 mm
6-dot system



100 mm

Recorder output terminal

This terminal outputs the temperature and relative humidity in the test area.

Humidity sensor (for temperature & humidity chambers only)

Eliminates the need to change wicks and can accommodate a range of measurements impossible with a dry bulb sensor, including low humidity ranges.

Thermocouple

Used for arbitrary temperature measurement points inside the temperature (humidity) chamber or measuring the specimen temperature.

Interior plug socket

To supply power inside the chamber. We provide two types of sockets according to use.



Time signal terminal

Adds additional terminals to the standard time signal terminals.

Remote control function

Test conditions can be changed and operation can be started or stopped from your PC over an Ethernet connection. (Web browser)

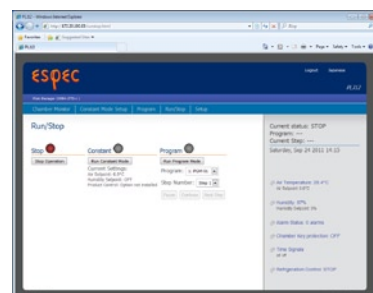

Run/stop operation

Interface

Communication port to connect the chamber to a PC.

- RS-485
- RS-232C
- GPIB

Communication cables

- RS-485 5 m / 10 m / 30 m
- RS-232C 1.5 m / 3 m / 6 m
- GPIB 2 m / 4 m

Additional cable port

Provided addition/replacement of the standard cable port (50 mm)

- ø25 mm
 - ø50 mm
 - ø100 mm
 - ø150 mm
- (Internal diameter)



ø50 mm

OPTIONS

Enlarged viewing window

The standard window (W180×H289 mm) can be changed to a larger type (W440×H295 mm). Tempered heat-resistant glass with defogging heater.



Large viewing window

Viewing window (installed on chamber wall)

Two viewing windows are available:

- Small (W350 × H250 mm)
- Large (W600 × H400 mm)

Heatproof reinforced glass with heat generator incorporated.

Hand-in ports (with viewing window W350 × H 250 mm)

Inner diameter: 150 mm (1 pair).

Useful when handling specimens in the chamber from outside.

Chamber lamp

- LED (adds the same as the standard accessory)
- Fluorescent lamp, ON when room temperature is +5°C to +40°C
- Incandescent lamp

Floor reinforcement

Distributes the concentrated load that occurs when specimens are carried into the chamber on a trolley, preventing distortions and dents in the floor. Additional frames to support the floor panels also enhance distributed load resistance.

Protective flooring (rubber type)

Prevents operators from slipping and prevents damage and dents.

Full-ceiling air duct

Lowers and stabilize air circulation speed to protect specimen.

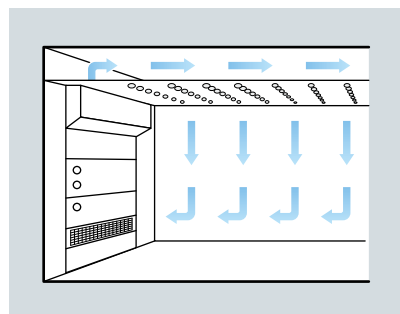

Insertion ramp

This ramp is used to move heavy specimens into the chamber. The ramp is available in a removable type and a lever type.

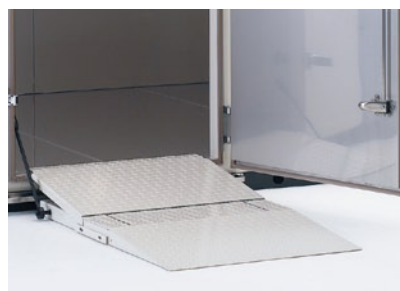

Insertion ramp (lever type)

Double swing door

The standard single door (W850 × H1800 mm) can be changed for a double swing door (W1400 × H1800 mm).



Additional door

Two types are available: single-swing and double-swing doors. Both come with a viewing window (W180 × H289 mm).

Entrance curtain

Prevents atmospheric disturbance of temp. and humid. within the chamber when opening and closing the door.

Preparation room

Minimizes atmospheric disturbance of temperature and humidity when opening and closing the door. Also used as a measurement room for specimens.

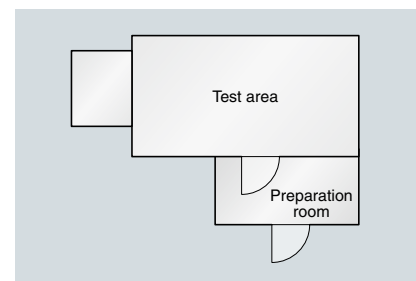

OPTIONS

Frost-free expansion (temperature & humidity chamber only)

Expands the temperature and humidity control range on the low temperature side and increases continuous operation time by preventing frost formation.

Airflow adjuster

Used when tests require low airflow velocity or a constant velocity.
Setting value range: 4 levels

Low humidity equipment (for temperature and humidity chambers only)

Expands the low-humidity range at low temperatures by using a dry-bulb dehumidifier.

Refrigerator for heat load

Refrigerators can be added to allow heat generation from the specimen during operation.

Auxiliary humidifier (for temperature & humidity chambers only)

Effective for heat load generation and high humidity specification. Pure water required.

Air-cooled inverter chiller system

Supplies cooling water to water-cooled equipment. The system features a sealed circuit that can reduce the need to clean pipes.

- Water supply temperature 20 to 25°C

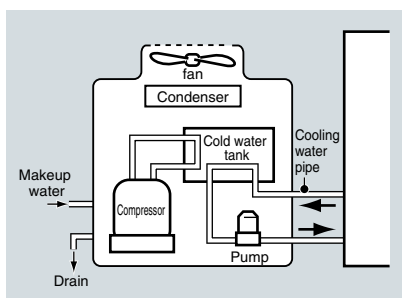

Water purifier (for temperature & humidity chambers only)

Connects to the boiler humidifier and optional auxiliary humidifiers. Improves the reliability of measurements over long periods of time and extends the life of the humidifiers.

- Reverse osmosis membrane water purifier
- Ion-exchange water purifier



Reverse osmosis membrane water purifier



Ion-exchange water purifier

Flow switch (for water-cooled models only)

This safety switch for refrigeration unit activates when the cooling water level becomes too low or cut off, and shuts down the equipment.

Exhaust air duct (for air-cooled type)

Exhausts hot air out of the refrigeration system. Installed on the upper part of the machinery compartment.

Operation Manual

- DVD
- Booklet

Safety precautions

- Do not use specimens which are explosive or inflammable, or which contain such substances.
To do so could be hazardous, as this may lead to fire or explosion.
- Do not place corrosive materials in the chamber. If corrosive substances or liquid is used, the life of the unit may be significantly shortened specifically because of the corrosion of stainless steel, resin and silicone materials.
- Be sure to read the operation manual before operation.

Please contact us for non-standard specification.

ESPEC CORP. <http://www.espec.co.jp/english>

Head Office

3-5-6, Tenjinbashi, Kita-ku, Osaka 530-8550, Japan
Tel: 81-6-6358-4741 Fax: 81-6-6358-5500

ESPEC NORTH AMERICA, INC.

Tel: 1-616-896-6100 Fax: 1-616-896-6150

ESPEC EUROPE GmbH

Tel: 49-89-1893-9630 Fax: 49-89-1893-96379

ESPEC (CHINA) LIMITED

Tel: 852-2620-0830 Fax: 852-2620-0788

ESPEC ENVIRONMENTAL EQUIPMENT (SHANGHAI) CO., LTD.

Head Office

Tel: 86-21-51036677 Fax: 86-21-63372237

BEIJING Branch

Tel: 86-10-64627025 Fax: 86-10-64627036

TIANJIN Branch

Tel: 86-22-26210366 Fax: 86-22-26282186

GUANGZHOU Branch

Tel: 86-20-83317826 Fax: 86-20-83317825

SHENZHEN Branch

Tel: 86-755-83674422 Fax: 86-755-83674228

SUZHOU Branch

Tel: 86-512-68028890 Fax: 86-512-68028860

ESPEC TEST TECHNOLOGY (SHANGHAI) CO., LTD.

Tel: 86-21-68798008 Fax: 86-21-68798088

ESPEC SOUTH EAST ASIA SDN.BHD.

Tel: 60-3-8945-1377 Fax: 60-3-8945-1287



QMS
JIS Q 9001
JSAQ 004



MS
JAB
CM001



MS
JAB
CM021



ISO 9001/JIS Q 9001

Quality Management System Assessed and Registered

ESPEC CORP. has been assessed by and registered in the Quality Management System based on the International Standard ISO 9001:2008 (JIS Q 9001:2008) through the Japanese Standards Association (JSA).

* Registration : ESPEC CORP.
(Overseas subsidiaries not included)

ISO 14001 (JIS Q 14001)

Environmental Management System Assessed and Registered

ESPEC CORP.

- Specifications are subject to change without notice due to design improvements.
- Corporate names and trade names mentioned in this catalog are trademarks or registered trademarks.